

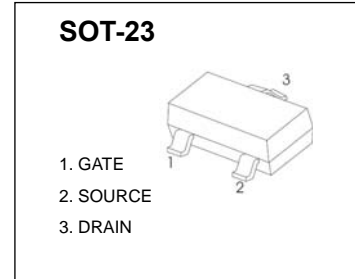

SOT-23 Plastic-Encapsulate MOSFETS

CJ2312 N-Channel 20-V(D-S) MOSFET

$V_{(BR)DSS}$	$R_{DS(on)MAX}$	I_D
20V	31.8mΩ@4.5V	5A
	35.6mΩ@2.5V	
	41.4mΩ@1.8V	



FEATURE

- TrenchFET Power MOSFET

APPLICATION

- DC/DC Converters
- Load Switching for Portable Applications

MARKING

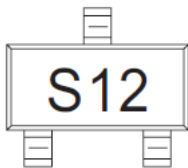

Equivalent Circuit

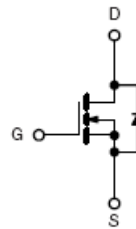

Maximum ratings ($T_a=25^{\circ}C$ unless otherwise noted)

Parameter	Symbol	Value	Unit
Drain-Source Voltage	V_{DS}	20	V
Gate-Source Voltage	V_{GS}	± 8.0	
Continuous Drain Current	I_D (t=5s)	5	A
Pulsed Drain Current	I_{DM}	20	
Continuous Source-Drain Diode Current	I_S	1.04	
Maximum Power Dissipation	P_D (t=5s)	0.35	W
Thermal Resistance from Junction to Ambient	$R_{\theta JA}$	357	$^{\circ}C/W$
Operation Junction and Storage Temperature Range	T_J, T_{stg}	-50 ~ +150	$^{\circ}C$

MOSFET ELECTRICAL CHARACTERISTICS

$T_a=25\text{ }^\circ\text{C}$ unless otherwise specified

Parameter	Symbol	Test Condition	Min	Typ	Max	Unit
Static						
Drain-source breakdown voltage	$V_{(BR)DSS}$	$V_{GS} = 0V, I_D = 250\mu A$	20			V
Gate-source leakage	I_{GSS}	$V_{DS} = 0V, V_{GS} = \pm 8V$			± 100	nA
Zero gate voltage drain current	I_{DSS}	$V_{DS} = 20V, V_{GS} = 0V$			1.0	μA
Gate-source threshold voltage	$V_{GS(th)}$	$V_{DS} = V_{GS}, I_D = 250\mu A$	0.45	0.7	1.0	V
Drain-source on-state resistance ^a	$R_{DS(on)}$	$V_{GS} = 4.5V, I_D = 5.0A$		0.018	0.0318	Ω
		$V_{GS} = 2.5V, I_D = 4.7A$		0.023	0.0356	
		$V_{GS} = 1.8V, I_D = 4.3A$		0.030	0.0414	
Forward transconductance ^a	g_{fs}	$V_{DS} = 10V, I_D = 5.0A$		6		S
Dynamic^b						
Input capacitance	C_{iss}	$V_{DS} = 10V, V_{GS} = 0V, f = 1MHz$		865		μF
Output capacitance	C_{oss}			105		
Reverse transfer capacitance	C_{rss}			55		
Gate resistance	R_g	$f = 1MHz$	0.5		4.8	Ω
Turn-on delay Time	$t_{d(on)}$	$V_{GEN} = 5V, V_{DD} = 10V,$ $I_D = 4A, R_G = 1\Omega, R_L = 2.2\Omega$			10	ns
Rise time	t_r				20	
Turn-off Delay time	$t_{d(off)}$				32	
Fall time	t_f				12	
Drain-source body diode characteristics						
Forward diode voltage	V_{SD}	$V_{GS} = 0V, I_S = 4A$		0.75	1.2	V

Notes :

- Pulse Test : pulse width $\leq 300\mu s$, duty cycle $\leq 2\%$.
- These parameters have no way to verify.

Typical Characteristics

Output Characteristics

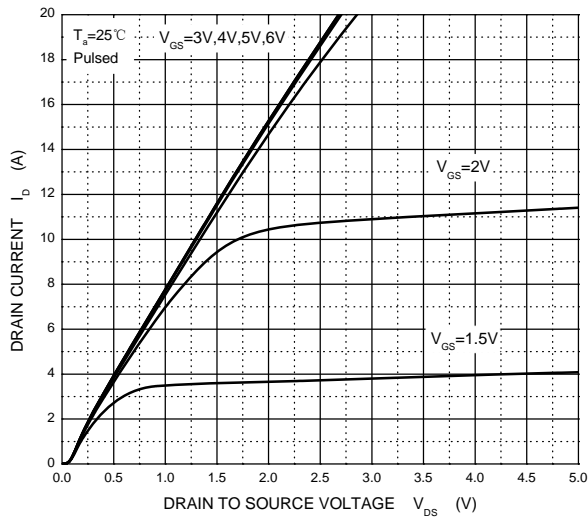

Transfer Characteristics

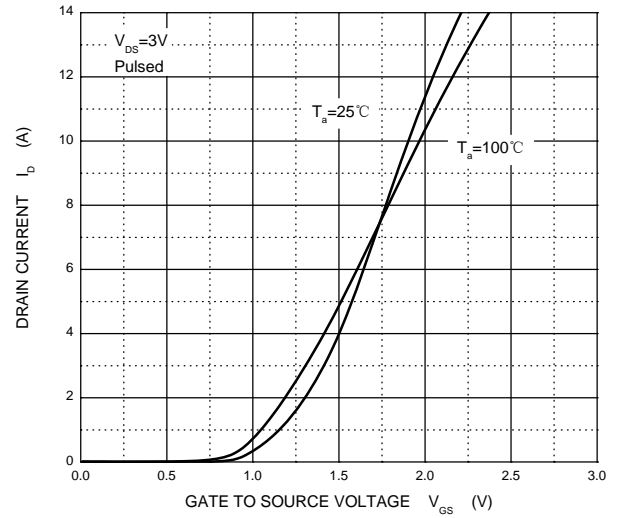

$R_{DS(ON)}$ — I_D

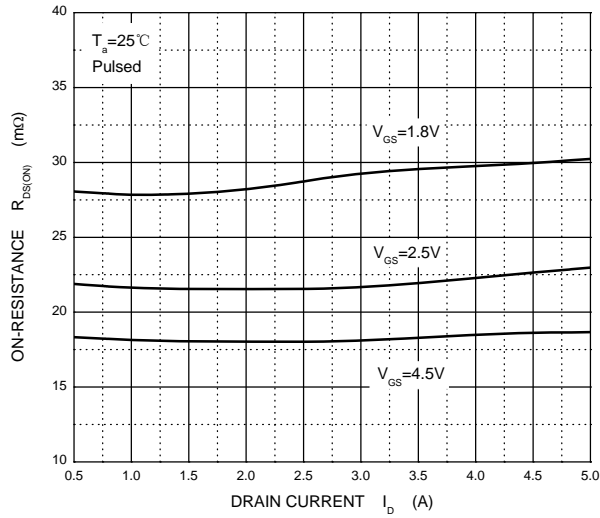

$R_{DS(ON)}$ — V_{GS}

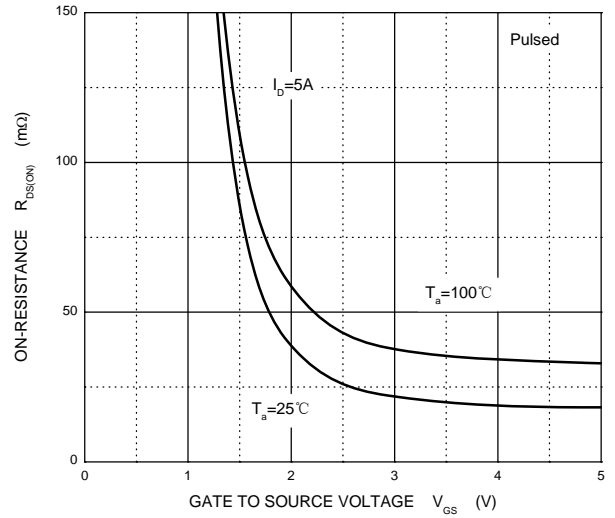

I_S — V_{SD}

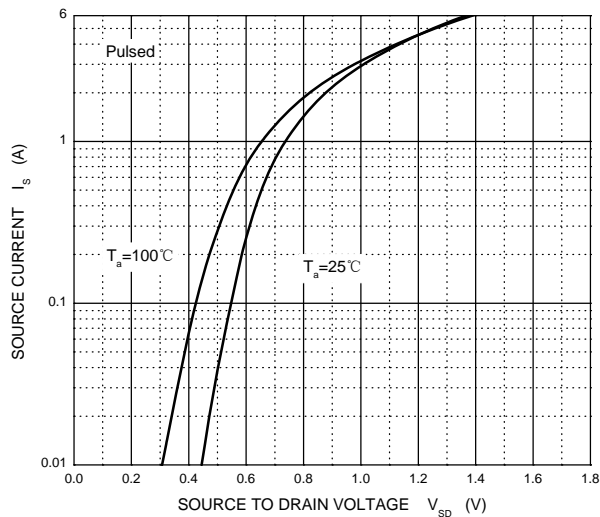

Threshold Voltage

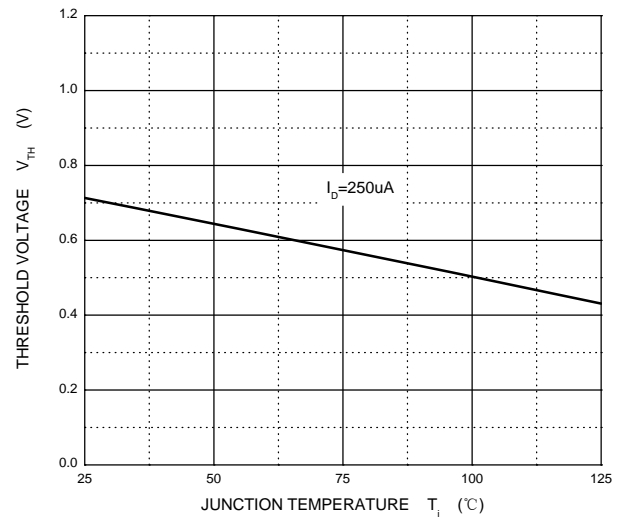

SOT-23 Package Outline Dimensions

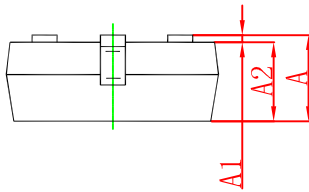
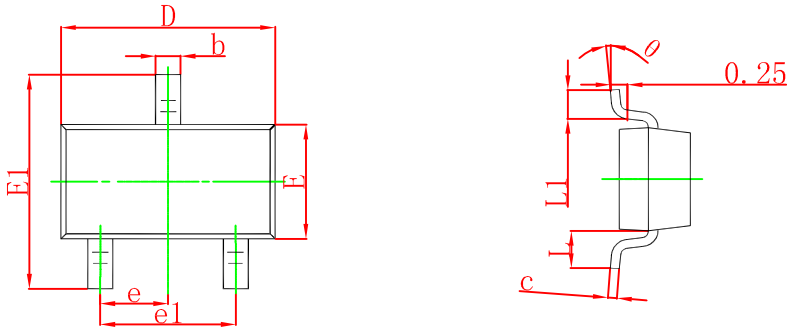

Symbol	Dimensions In Millimeters		Dimensions In Inches	
	Min	Max	Min	Max
A	0.900	1.150	0.035	0.045
A1	0.000	0.100	0.000	0.004
A2	0.900	1.050	0.035	0.041
b	0.300	0.500	0.012	0.020
c	0.080	0.150	0.003	0.006
D	2.800	3.000	0.110	0.118
E	1.200	1.400	0.047	0.055
E1	2.250	2.550	0.089	0.100
e	0.950 TYP		0.037 TYP	
e1	1.800	2.000	0.071	0.079
L	0.550 REF		0.022 REF	
L1	0.300	0.500	0.012	0.020
θ	0°	8°	0°	8°

SOT-23 Suggested Pad Layout

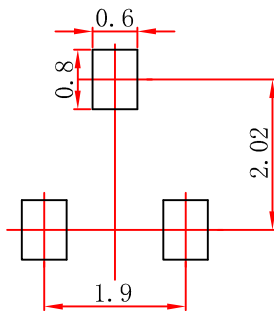

Note:

1. Controlling dimension: in millimeters.
2. General tolerance: ± 0.05 mm.
3. The pad layout is for reference purposes only.

NOTICE

JSCJ reserves the right to make modifications, enhancements, improvements, corrections or other changes without further notice to any product herein. JSCJ does not assume any liability arising out of the application or use of any product described herein.

SOT-23 Tape and Reel

SOT-23 Embossed Carrier Tape

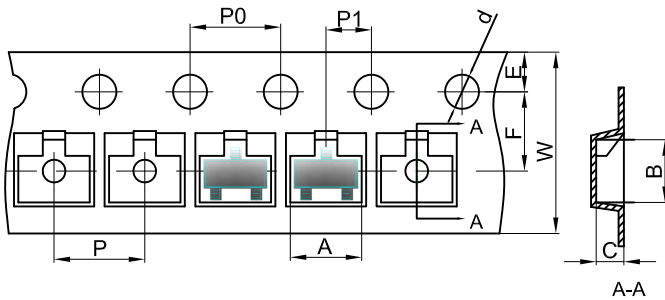

Packaging Description:

SOT-23 parts are shipped in tape. The carrier tape is made from a dissipative (carbon filled) polycarbonate resin. The cover tape is a multilayer film (Heat Activated Adhesive in nature) primarily composed of polyester film, adhesive layer, sealant, and anti-static sprayed agent. These reeled parts in standard option are shipped with 3,000 units per 7" or 17.8cm diameter reel. The reels are clear in color and is made of polystyrene plastic (anti-static coated).

Dimensions are in millimeter

Pkg type	A	B	C	d	E	F	P0	P	P1	W
SOT-23	3.15	2.77	1.22	Ø1.50	1.75	3.50	4.00	4.00	2.00	8.00

SOT-23 Tape Leader and Trailer

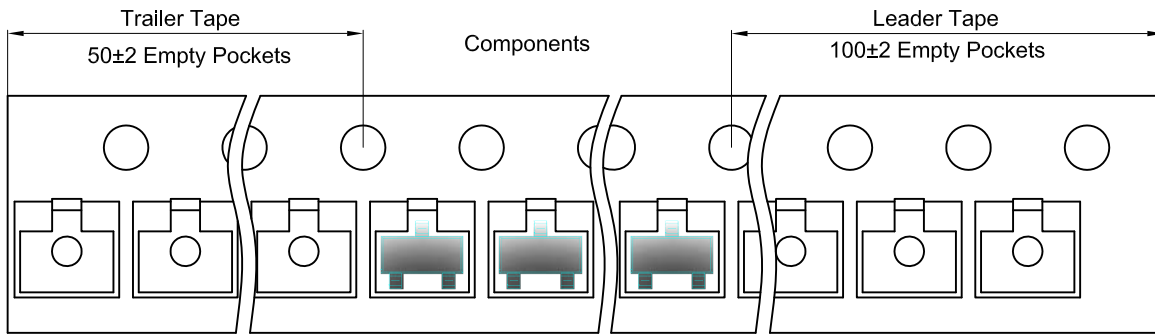

SOT-23 Reel

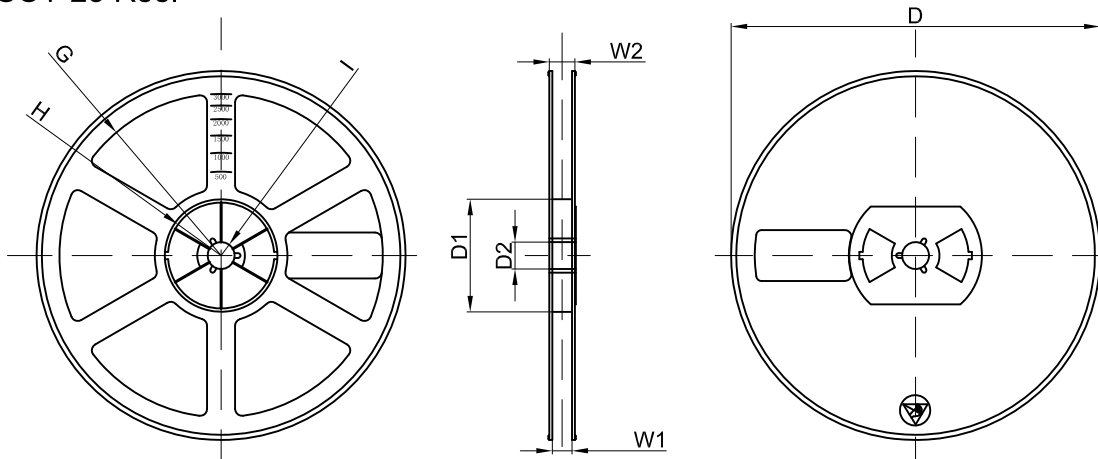

Dimensions are in millimeter

Reel Option	D	D1	D2	G	H	I	W1	W2
7"Dia	Ø178.00	54.40	13.00	R78.00	R25.60	R6.50	9.50	12.30

REEL	Reel Size	Box	Box Size(mm)	Carton	Carton Size(mm)	G.W.(kg)
3000 pcs	7 inch	30,000 pcs	203×203×195	120,000 pcs	438×438×220	